

10. PROFILE TYPU C

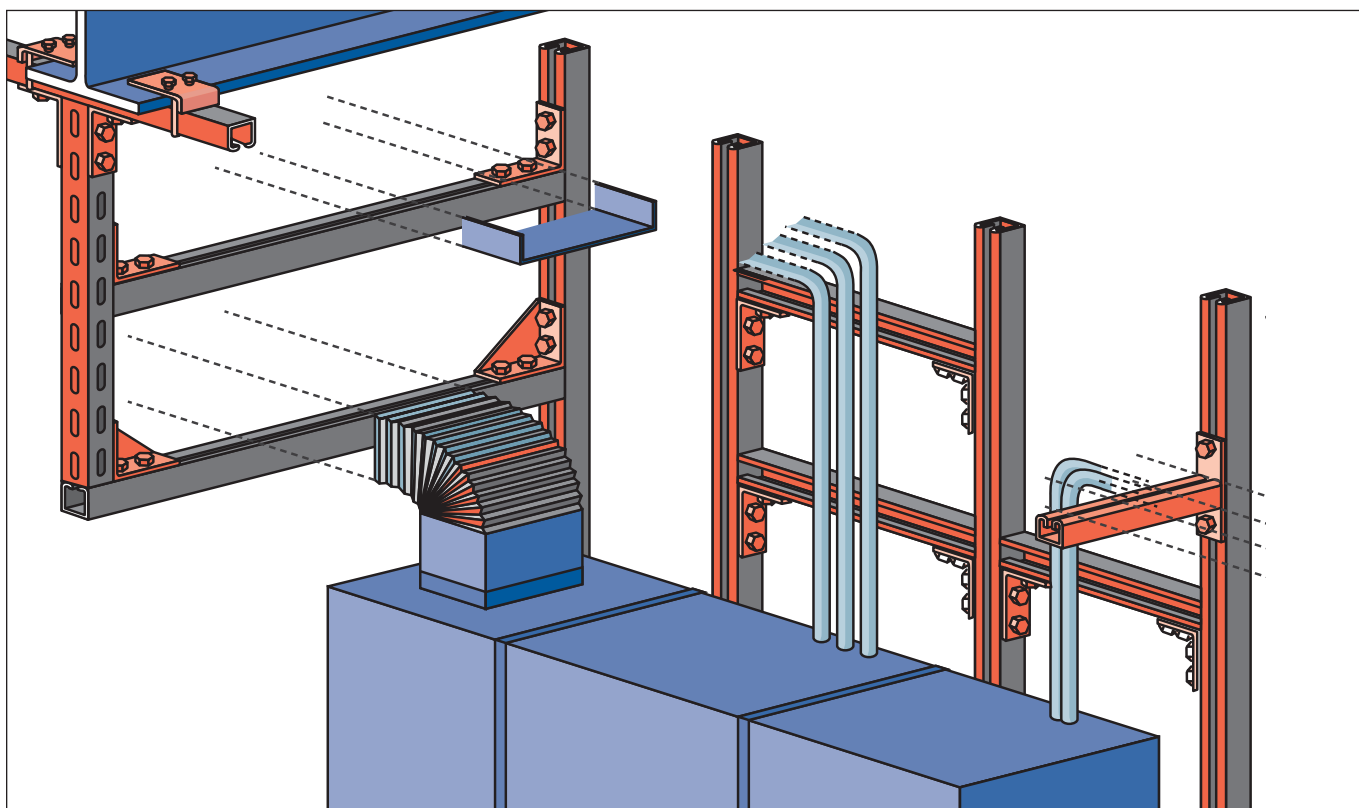

| | | | | |
|---|---|---|--|---|
|  |  |  |  |  |
| 124 E0 | 124 E2 | 125 C-E0 | 125 C-E4 | 126 C-EB |



| | | | | |
|---|---|---|---|---|
|  |  |  |  |  |
| 127 EB 25 | 128 PLN | 131 APX | 133 BF | 133 C-FIX M |

E0L • E0



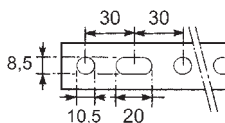

|  | N° | L m | P |  |
|---|--------|--------|---|---|
| E0L 2 m 27 x 18 x 1,25 | 599996 | 2 | 1 | 10 |
| E0 2 m 27 x 30 x 1,5 | 599997 | 2 | 1 | 10 |



 p. 190

E1



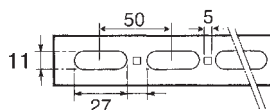

|  | N° | L m | P |  |
|---|--------|--------|---|---|
| E1 2 m 30 x 15 x 2 | 585500 | 2 | 1 | 10 |



 p. 190

E2L • E2



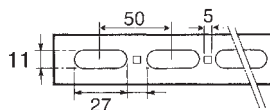

|  | N° | L m | P |  |
|---|--------|--------|---|---|
| E2L 2 m 34 x 20 x 1,5 | 585480 | 2 | 1 | 10 |
| E2 2 m 34 x 20 x 2,4 | 585470 | 2 | 1 | 10 |



 p. 191

E3



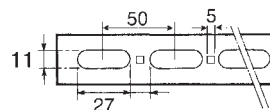

|  | N° | L m | P |  |
|---|--------|--------|---|---|
| E3 2 m 35 x 35 x 2 | 585560 | 2 | 1 | 10 |
| E3 3 m 35 x 35 x 2 | 585550 | 3 | 1 | 10 |
| E3 6 m 35 x 35 x 2 | 585540 | 6 | 1 | 10 |



 p. 192

E4



|  | N° | L m | P |  |
|---|--------|--------|---|---|
| E4 2 m 38 x 40 x 2 | 599998 | 2 | 1 | 10 |
| E4 3 m 38 x 40 x 2 | 600000 | 3 | 1 | 10 |
| E4 6 m 38 x 40 x 2 | 599999 | 6 | 1 | 10 |

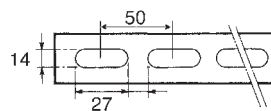



 p. 192



C-E0L



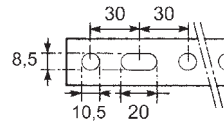
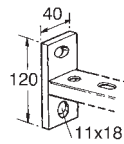

|  | N° | L m | P |  |
|---|--------|--------|---|---|
| C-E0L 27 x 18 180 mm | 599879 | 180 | 1 | 25 |
| C-E0L 27 x 18 300 mm | 599880 | 300 | 1 | 25 |



 p. 193

C-E0



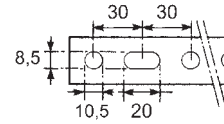
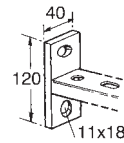

|  | N° | L m | P |  |
|---|--------|--------|---|---|
| C-E0 27 x 30 180 mm | 599885 | 180 | 1 | 25 |
| C-E0 27 x 30 240 mm | 599890 | 240 | 1 | 25 |
| C-E0 27 x 30 300 mm | 599900 | 300 | 1 | 25 |
| C-E0 27 x 30 360 mm | 599905 | 360 | 1 | 25 |
| C-E0 27 x 30 420 mm | 599910 | 420 | 1 | 10 |
| C-E0 27 x 30 540 mm | 599920 | 540 | 1 | 1 |
| C-E0 27 x 30 660 mm | 599925 | 660 | 1 | 1 |
| C-E0 27 x 30 780 mm | 599930 | 780 | 1 | 1 |



 p. 193

C-E2



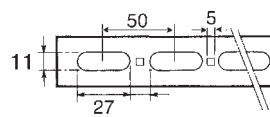
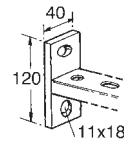

|  | N° | L m | P |  |
|--|--------|--------|---|--|
| C-E2 34 x 20 200 mm | 597500 | 200 | 1 | 20 |
| C-E2 34 x 20 300 mm | 597510 | 300 | 1 | 20 |



 p. 194

C-E3



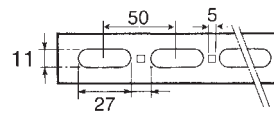
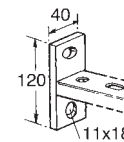

|  | N° | L m | P |  |
|---|--------|--------|---|---|
| C-E3 35 x 35 250 mm | 585860 | 250 | 1 | 20 |
| C-E3 35 x 35 500 mm | 585870 | 500 | 1 | 10 |
| C-E3 35 x 35 750 mm | 585880 | 750 | 1 | 1 |
| C-E3 35 x 35 1000 mm | 585890 | 1000 | 1 | 1 |



 p. 194

C-E4





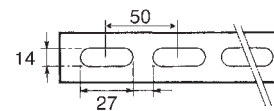
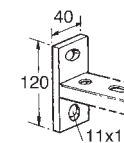

|  | N° | L m | P |  |
|---|--------|--------|---|---|
| C-E4 38 x 40 200 mm | 599935 | 200 | 1 | 25 |
| C-E4 38 x 40 250 mm | 599940 | 250 | 1 | 25 |
| C-E4 38 x 40 300 mm | 599950 | 300 | 1 | 25 |
| C-E4 38 x 40 350 mm | 599960 | 350 | 1 | 25 |
| C-E4 38 x 40 450 mm | 599970 | 450 | 1 | 10 |
| C-E4 38 x 40 550 mm | 599980 | 550 | 1 | 1 |
| C-E4 38 x 40 650 mm | 599990 | 650 | 1 | 1 |
| C-E4 38 x 40 800 mm | 599995 | 800 | 1 | 1 |



 p. 195

ADK





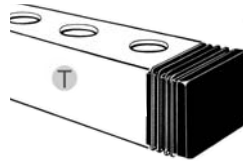

|  |  |  |  |
|---|---|---|---|
| ADK E3 | 585400 | 11 | 100 |
| ADK E1 | 585380 | 11 | 100 |
| ADK E0L | 313301 | 11 | 100 |
| ADK E0 | 313302 | 11 | 100 |
| ADK E4 | 313303 | 11 | 100 |
| ADK E2 | 313304 | 11 | 100 |



C-EB





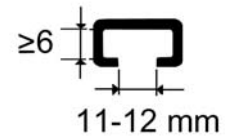
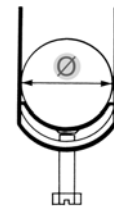
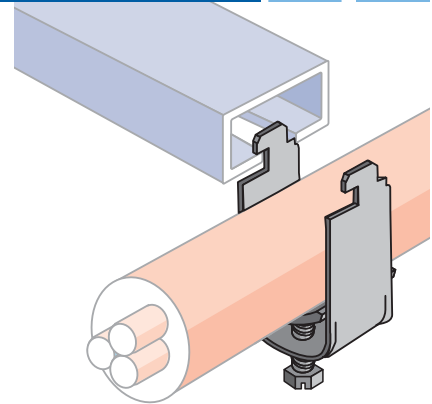

|  |  | \varnothing mm |  |  |
|---|---|---------------------|---|---|
| C 12EB | 338100 | 6-12 | 3 | 250 |
| C 16EB | 338110 | 12-16 | 3 | 250 |
| C 20EB | 338120 | 16-20 | 3 | 250 |
| C 24EB | 338130 | 20-24 | 3 | 250 |
| C 28EB | 338140 | 24-28 | 3 | 250 |
| C 32EB | 338150 | 28-32 | 3 | 200 |
| C 36EB | 338160 | 32-36 | 3 | 200 |
| C 40EB | 338170 | 36-40 | 3 | 200 |
| C 44EB | 338180 | 40-44 | 3 | 100 |
| C 48EB | 338190 | 44-48 | 3 | 100 |
| C 52EB | 338200 | 48-52 | 3 | 100 |
| C 56EB | 338210 | 52-56 | 3 | 100 |
| C 60EB | 338220 | 56-60 | 3 | 100 |
| C 64EB | 338230 | 60-64 | 3 | 100 |
| C 70EB | 338240 | 64-70 | 3 | 50 |



EB 25 (E0-E2)



|  |  | A mm | B mm | C mm | E mm |  |  |
|---|---|------|------|------|------|---|---|
| EB25 90° | 584660 | 25 | 45 | 45 | 5 | 1 | 25 |
| EB25 135° | 584662 | 25 | 45 | 45 | 5 | 1 | 25 |
| EBL25 90° | 584666 | 25 | 90 | 90 | 5 | 1 | 25 |
| EBL25 135° | 584668 | 25 | 90 | 90 | 5 | 1 | 25 |

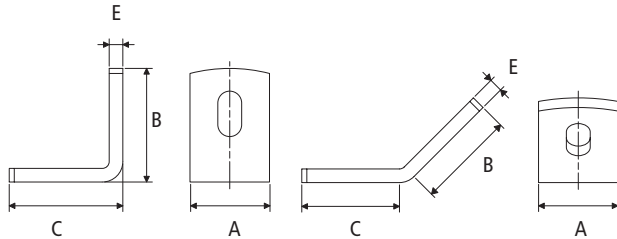

EB25 135°



EB25 90°



EBL25 135°







EBL25 90°



EB 35 (E2-E4)



|  |  | A mm | B mm | C mm | E mm |  |  |
|---|---|------|------|------|------|---|---|
| EB35 90° | 587530 | 35 | 50 | 50 | 6 | 1 | 25 |
| EB35 135° | 587500 | 35 | 50 | 50 | 6 | 1 | 25 |
| EBL35 90° | 587510 | 35 | 85 | 85 | 6 | 1 | 25 |
| EBL35 135° | 587520 | 35 | 85 | 85 | 6 | 1 | 25 |

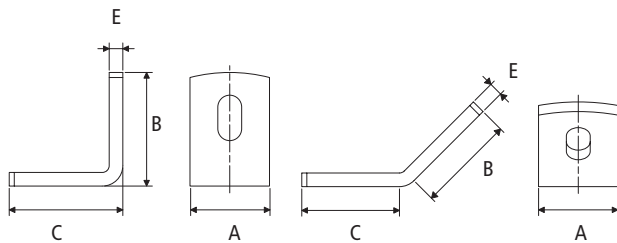

EB35 135°



EB35 90°



EBL35 135°



EBL35 90°



PL • PLN



| | N ^o | Ø mm | B mm | S mm | E mm | P | |
|--------------------|----------------|------|------|------|------|---|----|
| PL UNI-10,5 | 588290 | 10,5 | 23 | 2 | 40 | 1 | 50 |
| PLN E0-8,4 mm | 588240 | 8,5 | 30 | 2 | 28 | 1 | 50 |
| PLN E0-10,5 mm | 588250 | 10,5 | 30 | 2 | 28 | 1 | 50 |
| PLN E1/E2-8,4 mm | 588260 | 8,5 | 30 | 2 | 31 | 1 | 50 |
| PLN E1/E2-10,5 mm | 588270 | 10,5 | 30 | 2 | 31 | 1 | 50 |
| PLN E3/E4-8,4 mm | 588280 | 8,5 | 30 | 2 | 39 | 1 | 50 |
| PLN E3/E4--10,5 mm | 588285 | 10,5 | 30 | 2 | 39 | 1 | 50 |

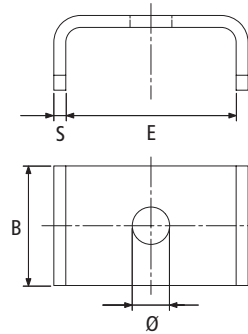

ECN (E1)





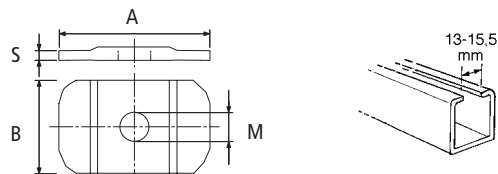

| | N ^o | M mm | A mm | B mm | S mm | P | |
|-------------|----------------|------|------|------|------|---|-----|
| ECN UNI M6 | 585430 | 6 | 24 | 15 | 5 | 1 | 100 |
| ECN UNI M8 | 585440 | 8 | 24 | 15 | 5 | 1 | 100 |
| ECN UNI M10 | 585450 | 10 | 24 | 15 | 5 | 1 | 100 |



ECN (EOL/E0)





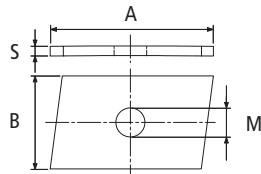

|  |  | M mm | A mm | B mm | S mm |  |  |
|---|---|---------|---------|---------|---------|---|---|
| ECN EOL/E0 M6 | 315370 | 6 | 25 | 14 | 4 | 1 | 100 |
| ECN EOL/E0 M8 | 315340 | 8 | 25 | 14 | 4 | 1 | 100 |
| ECN EOL/E0 M10 | 315350 | 10 | 25 | 14 | 4 | 1 | 100 |



ECN (E2L/E2/E3)





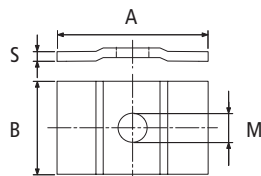

|  |  | M mm | A mm | B mm | S mm |  |  |
|---|---|---------|---------|---------|---------|---|---|
| ECN E2L/E2/E3 M6 | 585250 | 6 | 29 | 13 | 5 | 1 | 100 |
| ECN E2L/E2/E3 M8 | 585260 | 8 | 29 | 13 | 5 | 1 | 100 |
| ECN E2L/E2/E3 M10 | 585270 | 10 | 29 | 13 | 5 | 1 | 100 |



ECN (E4)





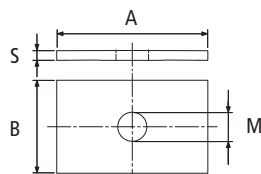

|  |  | M mm | A mm | B mm | S mm |  |  |
|---|---|---------|---------|---------|---------|---|---|
| ECN E4 M8 | 315330 | 6 | 30 | 23 | 6 | 1 | 100 |
| ECN E4 M10 | 315360 | 8 | 30 | 23 | 6 | 1 | 100 |



RAC E3





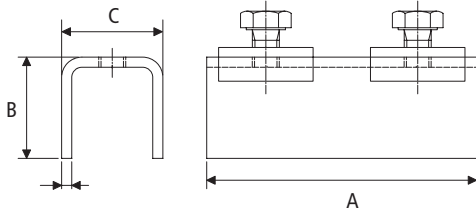

|  |  | A mm | B x C mm |  |  |
|---|---|---------|-------------|---|---|
| RAC E3 | 585780 | 80 | 30 x 30 | 1 | 5 |



RAC E0/E4





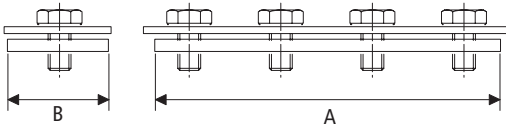

|  |  | A mm | B mm |  |  |
|---|---|---------|---------|---|---|
| RAC E0 | 588720 | 115 | 23 | 1 | 50 |
| RAC E4 | 588725 | 155 | 30 | 1 | 25 |



APX





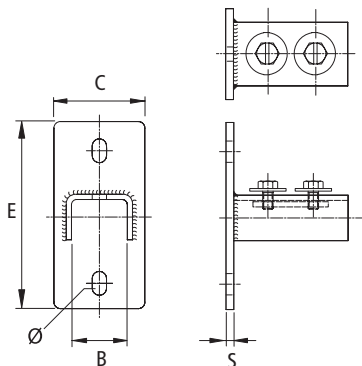

|  |  | B mm | C mm | E mm | S mm | Ø mm |  |  |
|---|---|------|------|------|------|---------|---|--|
| APX EOL/EO/E1 | 584715 | 31 | 50 | 114 | 5 | 12 x 19 | 1 | 10 |
| APX E2L/E2/E3 | 584710 | 36 | 50 | 114 | 5 | 12 x 19 | 1 | 10 |
| APX E4 | 584725 | 43 | 70 | 144 | 5 | 12 x 19 | 1 | 10 |



APY



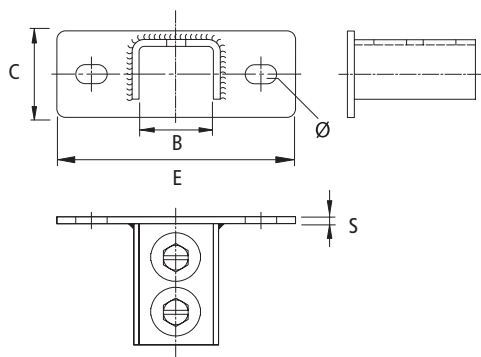

|  |  | B mm | C mm | E mm | S mm | Ø mm |  |  |
|---|---|------|------|------|------|---------|---|--|
| APY EOL/EO/E1 | 584758 | 31 | 40 | 124 | 5 | 12 x 19 | 1 | 10 |
| APY E2L/E2/E3 | 584740 | 36 | 40 | 124 | 5 | 12 x 19 | 1 | 10 |
| APY E4 | 584751 | 43 | 50 | 144 | 5 | 12 x 19 | 1 | 10 |



SH-SG (E0/E4)



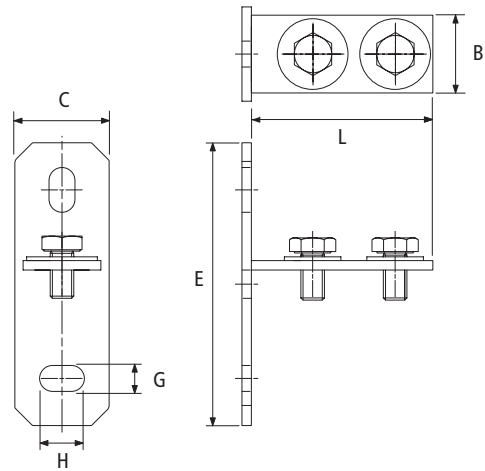

|  | N° | C mm | E mm | G x H mm | L x B mm | P |  |
|---|--------|------|------|----------|----------|---|---|
| SH-SG E0 | 584670 | 40 | 120 | 11 x 19 | 55 x 24 | 1 | 10 |
| SH-SG E4 | 584671 | 40 | 120 | 11 x 19 | 80 x 33 | 1 | 10 |



SH-LG (E0/E4)



|  | N° | C mm | E mm | G x H mm | L x B mm | P |  |
|---|--------|------|------|----------|----------|---|---|
| SH-LG E0 | 584672 | 40 | 120 | 11 x 19 | 55 x 24 | 1 | 10 |
| SH-LG E4 | 584673 | 40 | 120 | 11 x 19 | 80 x 33 | 1 | 10 |

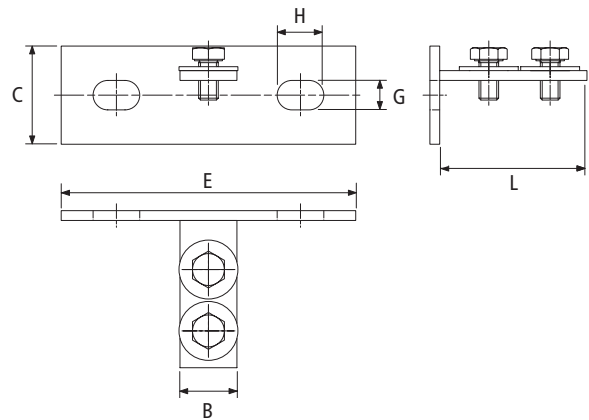

BF



| | | A mm | M | | |
|-------------|--------|---------|---|---|----|
| BF E0-E3 M6 | 585120 | 50 | 6 | 1 | 50 |
| BF E4 M8 | 585110 | 50 | 8 | 1 | 50 |

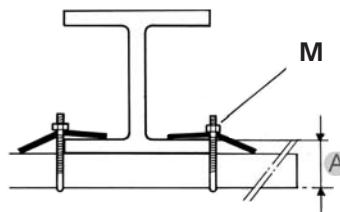

C-FIX



| C-FIX M6 | 584500 | 1 | 100 | 100 | 300 |
|-----------|--------|---|-----|-----|-----|
| C-FIX M8 | 584510 | 1 | 100 | 100 | 300 |
| C-FIX M10 | 584520 | 1 | 100 | 100 | 300 |

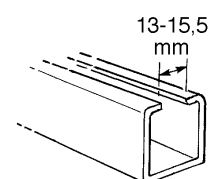





C-FIX M

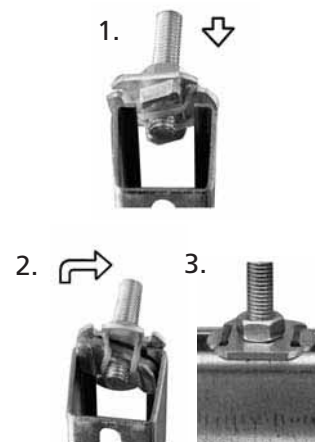

| C-FIX M8x30 | 584530 | 1 | 100 | 100 | 300 |
|---------------|--------|---|-----|-----|-----|
| C-FIX M8x40 | 584540 | 1 | 100 | 100 | 300 |
| C-FIX M8x60 | 584550 | 1 | 100 | 100 | 300 |
| C-FIX M8x80 | 584480 | 1 | 100 | 100 | 300 |
| C-FIX M8x100 | 584490 | 1 | 50 | 100 | 300 |
| C-FIX M8x120 | 584630 | 1 | 50 | 100 | 300 |
| C-FIX M8x150 | 584580 | 1 | 50 | 100 | 300 |
| C-FIX M10x40 | 584560 | 1 | 100 | 100 | 300 |
| C-FIX M10x60 | 584570 | 1 | 100 | 100 | 300 |
| C-FIX M10x80 | 584640 | 1 | 100 | 100 | 300 |
| C-FIX M10x100 | 584650 | 1 | 50 | 100 | 300 |





|  |  |  | \varnothing M x L | A x B mm |  |  |
|---|---|---|------------------------|-------------|---|---|
| KP 8x30 | 585050 | E2L/E2/E3 | 8 x 30 | 29 x 13 | 1 | 100 |
| KP 8x40 | 585000 | E2L/E2/E3 | 8 x 40 | 29 x 13 | 1 | 100 |
| KP 8x50 | 585060 | E2L/E2/E3 | 8 x 50 | 29 x 13 | 1 | 100 |
| KP 8x60 | 585010 | E2L/E2/E3 | 8 x 60 | 29 x 13 | 1 | 100 |
| KP 10x30 | 585020 | E2L/E2/E3 | 10 x 30 | 29 x 13 | 1 | 100 |
| KP 10x40 | 585030 | E2L/E2/E3 | 10 x 40 | 29 x 13 | 1 | 100 |
| KP 10x60 | 585040 | E2L/E2/E3 | 10 x 60 | 29 x 13 | 1 | 100 |
| | | | | | | |
| KP27 M8x20 | 590074 | EOL/E0/E1 | 8 x 20 | 25 x 14 | 1 | 100 |
| KP27 M8x25 | 590075 | EOL/E0/E1 | 8 x 25 | 25 x 14 | 1 | 100 |
| KP27 M8x30 | 590076 | EOL/E0/E1 | 8 x 30 | 25 x 14 | 1 | 100 |
| KP27 M8x40 | 590077 | EOL/E0/E1 | 8 x 40 | 25 x 14 | 1 | 100 |
| KP27 M8x50 | 590078 | EOL/E0/E1 | 8 x 50 | 25 x 14 | 1 | 100 |
| KP27 M8x60 | 590079 | EOL/E0/E1 | 8 x 60 | 25 x 14 | 1 | 100 |
| KP27 M8x80 | 590082 | EOL/E0/E1 | 8 x 70 | 25 x 14 | 1 | 100 |
| KP27 M8x100 | 590083 | EOL/E0/E1 | 8 x 80 | 25 x 14 | 1 | 50 |
| KP27 M10x30 | 590087 | EOL/E0/E1 | 10 x 30 | 25 x 14 | 1 | 100 |
| KP27 M10x35 | 590088 | EOL/E0/E1 | 10 x 35 | 25 x 14 | 1 | 100 |
| KP27 M10x50 | 590089 | EOL/E0/E1 | 10 x 35 | 25 x 14 | 1 | 100 |
| | | | | | | |
| KP38 M8x25 | 590201 | E4 | 8 x 25 | 30 x 23 | 1 | 100 |
| KP38 M8x35 | 590200 | E4 | 8 x 35 | 30 x 23 | 1 | 100 |
| KP38 M8x40 | 590210 | E4 | 8 x 40 | 30 x 23 | 1 | 100 |
| KP38 M8x50 | 590202 | E4 | 8 x 50 | 30 x 23 | 1 | 100 |
| KP38 M8x80 | 590203 | E4 | 8 x 80 | 30 x 23 | 1 | 100 |
| KP38 M8x100 | 590204 | E4 | 8 x 100 | 30 x 23 | 1 | 50 |
| KP38 M10x35 | 590207 | E4 | 10 x 35 | 30 x 23 | 1 | 100 |
| KP38 M10x50 | 590330 | E4 | 10 x 50 | 30 x 23 | 1 | 100 |
| KP38 M10x80 | 590208 | E4 | 10 x 80 | 30 x 23 | 1 | 100 |

