











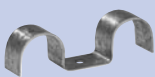
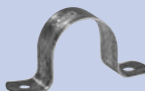

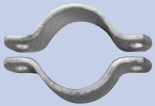
➤ 2.1 - 2.14



NIEIZOLOWANE OBEJMY DO RUR

				
2.2 CADDY® 250 MACROFIX M8/10	2.3 PX	2.4 CADDY® MACROFIX SE	2.5 CLEVIS HANGER 401	2.6 DSC W

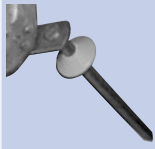
				
2.7 DSC P	2.7 1HPS	2.7 2PS	2.8 2HPS	2.8 HIB

				
2.8 HIBT	2.9 RS DIN	2.9 RSS	2.10 UPH	2.10 DPC

				
2.11 DPCM10	2.11 SDPC	2.11 DPC WP	2.12 U-BOLT DIN	2.12 U-BOLT

	
2.13 OD	2.14 EPB

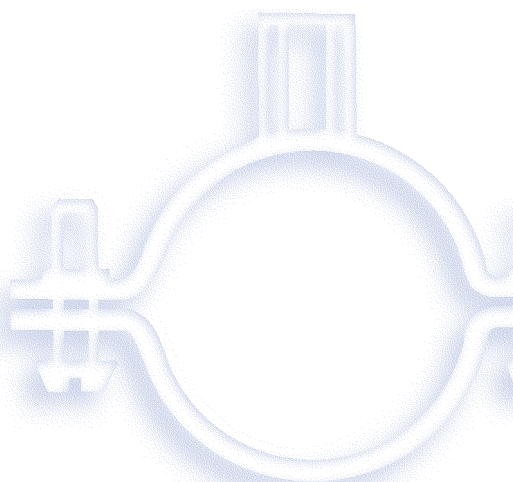



CADDY® 250 MACROFIX M8/M10



Dwuśrubowa obejma z nakrętką M8/M10

- nieizolowana
- wielofunkcyjny wkręt M6 z kombinowanym łbem sześciokątnym (z nacięciem i gniazdem krzyżkowym), w zestawie z podkładką
- wykończenie: ocynk galwaniczny
- profil stalowy (B x S)
- do rur o średnicach 14 - 315 mm



N ^o	∅ , ,	d mm	B x S mm	Sc x L			kg/1
596210	3/8	14-18	20x1,5	M6x20	1000	100	0,05
596220	1/2	20-26	20x1,5	M6x20	1000	100	0,05
596230	3/4	23-30	20x1,5	M6x20	1000	100	0,05
596250	1	33-40	20x1,5	M6x20	1000	100	0,07
596260	1 1/4	41-47	20x1,5	M6x20	1000	100	0,08
596270	1 1/2	48-54	20x2,0	M6x25	1000	50	0,08
596280	2	56-62	20x2,0	M6x25	1300	50	0,09
596290		62-69	20x2,0	M6x25	1300	50	0,09
596300		67-71	20x2,0	M6x25	1300	50	0,13
596310	2 1/2	69-78	20x2,0	M6x25	1300	25	0,17
596320	3	85-91	20x2,0	M6x25	1300	25	0,17
596330		90-98	23x2,5	M6x25	1300	25	0,17
596340		97-107	23x2,5	M6x25	1300	25	0,18
596350		104-110	23x2,5	M6x25	1300	25	0,20
596360	4	108-116	23x2,5	M8x25	1300	25	0,25
596370		116-126	23x2,5	M8x25	1300	25	0,25
596380		129-140	23x2,5	M8x25	2200	25	0,27
596390	5	133-141	23x2,5	M8x25	2200	25	0,28
596400		144-154	23x2,5	M8x25	2200	25	0,30
596410	6	159-168	23x2,5	M8x25	2200	25	0,28
596420		168-176	30x3,0	M8x25	2200	25	0,31
596430		174-184	30x3,0	M8x25	2200	25	0,41
596435	8	207-218	30x3,0	M8x25	2500	10	0,56
596445		225	30x3,0	M8x25	2500	10	0,59
596446		250	30x3,0	M8x25	2500	10	0,63
596447		274-280	30x3,0	M8x25	2700	10	0,68
596448		315	30x3,0	M8x25	2700	10	0,75

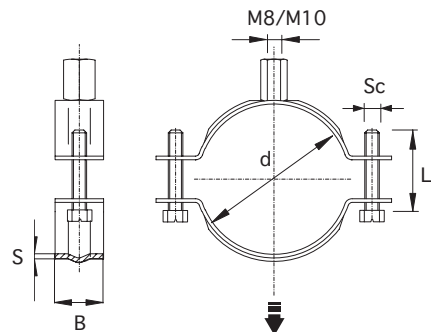

Obejma do dużych obciążeń

- podwójnie gwintowana nakrętka:
do 136 mm, z gwintem wewnętrznym M10
/ zewnętrznym 1/2"
do 252 mm, z gwintem wewnętrznym M12
/ zewnętrznym 3/4"
- wykończenie: ocynk galwaniczny
- profil stalowy (B x S)
- do rur o średnicach 21 - 252 mm



N ^o	Ø, "	d mm	B x S mm	Sc x L			kg/1
577060	1/2	21-25	27x2,2	M6x20	2500	25	0,11
577070	3/8	26-31	27x2,2	M6x20	2500	25	0,12
577080	1	32-36	27x2,2	M6x20	2500	25	0,13
577090		37-40	27x2,2	M6x20	2500	25	0,14
577100	1 1/4	41-46	27x2,2	M6x20	2500	25	0,14
577110	1 1/2	47-52	27x2,2	M6x20	2500	25	0,15
577120		53-58	27x2,2	M6x20	2500	25	0,16
577130	2	59-63	27x2,2	M6x20	2500	25	0,17
577140		64-67	27x2,2	M6x20	2500	25	0,17
577150		68-73	27x2,2	M6x20	2500	25	0,18
577160	2 1/2	74-79	31x2,4	M8x25	2500	25	0,25
577170		80-86	31x2,4	M8x25	2500	25	0,27
577180	3	87-92	31x2,4	M8x25	2500	25	0,27
577190		93-99	31x2,4	M8x25	2500	25	0,28
577200	3 1/2	100-105	31x2,4	M8x25	2500	25	0,30
577210		106-111	31x2,4	M8x25	2500	25	0,31
577220	4	112-117	31x2,4	M8x25	2500	10	0,32
577230		118-123	31x2,4	M8x25	2500	10	0,34
577240		124-129	31x2,4	M8x25	2500	10	0,35
577250		130-136	31x2,4	M8x25	2500	10	0,36
577260	5	137-143	38x3,0	M8x30	3500	10	0,55
577270		144-149	38x3,0	M8x30	3500	10	0,56
577280		150-156	38x3,0	M8x30	3500	10	0,58
577290		157-163	38x3,0	M8x30	3500	10	0,59
577300	6	164-169	38x3,0	M8x30	3500	10	0,62
577310		170-175	38x3,0	M8x30	3500	10	0,63
577320		176-182	38x3,0	M8x30	3500	10	0,66
577330		183-191	38x3,0	M8x30	3500	10	0,69
577340		192-198	38x3,0	M8x30	3500	10	0,70
577350		199-205	38x3,0	M8x30	3500	10	0,73
577360		206-212	38x3,0	M8x30	3500	10	0,75
577370	8	213-219	38x3,0	M8x30	3500	10	0,77
577380		226-232	38x3,0	M8x30	3500	10	0,78
577390		233-238	38x3,0	M8x30	3500	10	0,82
577400		246-252	38x3,0	M8x30	3500	10	0,84

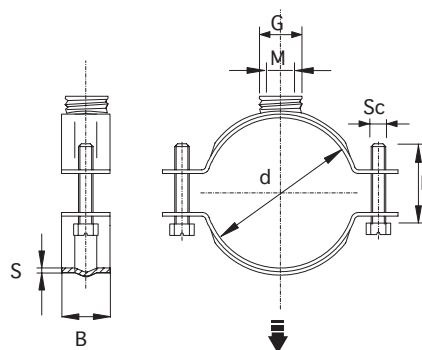

CADDY® MACROFIX SE



Dwuśrubowa obejma z nakrętką M8 (2 nakrętki 1/2" do 4" M10)

- wersja ekonomiczna
- niezmontowane, 5 sztuk w plastikowej torebce
- wielofunkcyjny wkręt M6
- wykończenie: ocynk galwaniczny
- profil stalowy (B x S)
- do rur o średnicach 17 - 118 mm



N ^o	∅ , ,	d mm	B x S mm	Sc x L			kg/1
595000	3/8	17-19	20x2,5	M6x16	2000	100	0,05
595001	1/2	20-23	20x2,5	M6x16	2000	100	0,05
595002	3/4	25-28	20x2,5	M6x16	2500	100	0,05
595003	1	32-36	20x2,5	M6x16	2500	100	0,07
595004	1 1/4	40-44	20x2,5	M6x16	2500	100	0,08
595005	1 1/2	47-50	20x2,5	M6x16	2500	100	0,08
595006	2	59-63	20x2,5	M6x16	2500	50	0,13
595007	2 1/2	75-80	20x2,5	M6x20	2500	50	0,16
595008	3	87-92	20x2,5	M6x20	3000	30	0,17
595009	4	113-118	20x2,5	M6x20	3000	30	0,25
595010	2 1/2	75-80	30x2,5	M6x20	2800	50	0,16
595011	3	87-92	30x2,5	M6x20	3200	30	0,17
595012	4	113-118	30x2,5	M6x20	3200	30	0,25

M8

M10

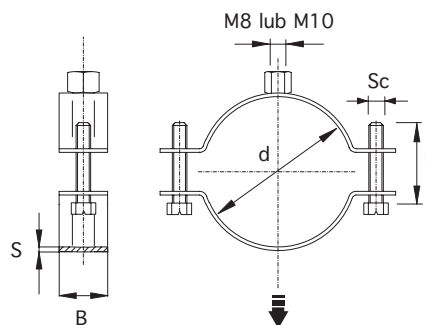

CADDY® MACROFIX SEK

Dwuśrubowa obejma z nakrętką M8 (2 nakrętki 1/2" do 4" M10)

- w komplecie z wkrętem dwustronnym
M8 x 90 mm (M10 x 120 mm)
- wersja ekonomiczna
- niezmontowane, 2 zestawy w plastikowej torebce
- wielofunkcyjny wkręt M6
- wykończenie: ocynk galwaniczny
- profil stalowy (B x S)
- do rur o średnicach 17 - 118 mm



N ^o	∅ , ,	d mm	B x S mm	Sc x L			kg/1	bs x ls
595020	3/8	17-19	20x2,5	M6x16	2000	100	0,08	M8x90
595021	1/2	20-23	20x2,5	M6x16	2000	100	0,08	M8x90
595022	3/4	25-28	20x2,5	M6x16	2500	100	0,08	M8x90
595023	1	32-36	20x2,5	M6x16	2500	100	0,10	M8x90
595024	1 1/4	40-44	20x2,5	M6x16	2500	100	0,11	M8x90
595025	1 1/2	47-50	20x2,5	M6x16	2500	100	0,11	M8x90
595026	2	59-63	20x2,5	M6x16	2500	50	0,16	M8x90
595027	2 1/2	75-80	20x2,5	M6x20	2500	50	0,19	M8x90
595028	3	87-92	20x2,5	M6x20	3000	30	0,20	M8x90
595029	4	113-118	20x2,5	M6x20	3000	30	0,28	M8x90
595030	2 1/2	75-80	30x2,5	M6x20	2800	50	0,19	M10x120
595031	3	87-92	30x2,5	M6x20	3200	30	0,20	M10x120
595032	4	113-118	30x2,5	M6x20	3200	30	0,28	M10x120

M8

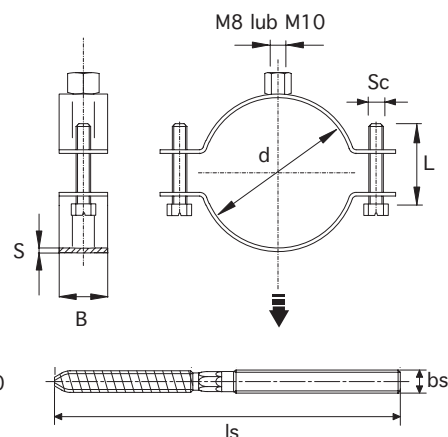

M10



Clevis Hanger 401

Wieszak 401

- wykończenie: ocynk galwaniczny
- do rur o średnicach 1" - 30"

N ^o	∅	G ∅ mm	H mm	H1 mm		FM UL	P 	kg/1
179420	1	10	69	51,6	2750		1 50	0,17
179421	1 1/4	10	84	61	2750		1 50	0,20
179422	1 1/2	10	100	75	2750		1 50	0,22
179423	2	10	114	83	2750		1 50	0,26
179424	2 1/2	12	133	95	5100	FM + UL	1 30	0,50
179425	3	12	152	101,6	5100	FM + UL	1 25	0,56
179426	4	16	197	137	6350	FM + UL	1 25	0,78
179427	5	16	248	173	6350	FM + UL	1 25	1,00
179428	6	19	298	210	8600	FM + UL	1 10	1,39
179429	8	22	356	341	9070	FM + UL	1 10	2,18
179430	10	22	419	277	16300		1 1	3,52
179431	12	22	473	305	17230		1 1	4,63
179432	14	27	552	368	19050		1 1	6,21
179433	16	27	610	400	20860		1 1	8,94
179434	18	30	679	445	21770		1 1	11,45
179435	20	33	762	499	21770		1 1	19,28
179436	24	33	867	552	21770		1 1	22,68
179437	30	33	1016	626	27210		1 1	31,52

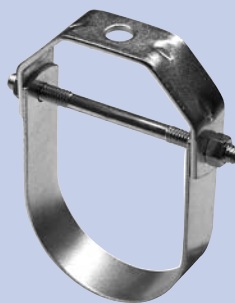

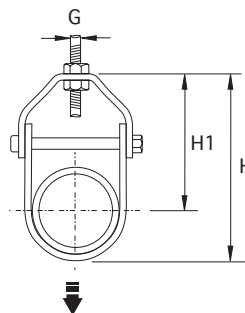

2 1/2 - 8":



Clevis Hanger 410

Wieszak 410 do małych obciążeń

- wykończenie: ocynk galwaniczny
- do rur o średnicach 1" - 12"

N ^o	∅	G ∅ mm	H mm	H1 mm		P 	kg/1
179400	1	10	102	72	1130	1 50	0,06
179401	1 1/4	10	108	82,6	1130	1 50	0,08
179402	1 1/2	10	114	82,6	1130	1 50	0,10
179403	2	10	127	90,5	1130	1 50	0,12
179404	2 1/2	12	138	95,3	1590	1 30	0,24
179405	3	12	152	101,6	1590	1 25	0,28
179406	4	16	208	146	1810	1 25	0,41
179407	5	16	254	180	8160	1 25	0,81
179408	6	19	282	194	8800	1 10	1,42
179409	8	19	355	242	9980	1 10	1,93
179410	10	22	420	278	16000	1 1	3,27
179411	12	22	473	305	17100	1 1	3,74

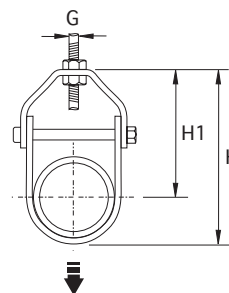

DSC G



Obejma ze szpilką

- kwadratowa szpilka o długości 80 mm, 3" 100 mm
- do rur gazowych i wodnych
- wkręty M6
- wykończenie: ocynk galwaniczny
- profil stalowy (B x S)
- do rur o średnicach 13,5 - 88,9 mm

N ^o	∅ ,,	d mm	B x S mm	Sc x L	E x F		kg/1
400283	1/4	13,5	20x1,5	M6x15		100	0,06
400284	3/8	17,2	20x1,5	M6x15		100	0,06
400285	1/2	21,3	20x1,5	M6x15		100	0,05
400286	3/4	26,9	20x1,5	M6x15		100	0,06
400287	1	33,7	20x1,5	M6x15		100	0,06
400288	1 1/4	42,4	20x1,5	M6x15	25x7	50	0,08
400289	1 1/2	48,3	20x2,0	M6x15	25x7	50	0,10
400290	2	60,3	20x2,0	M6x15	25x7	50	0,11
400291	2 1/2	76,1	20x2,0	M6x15	30x8	50	0,13
400292	3	88,9	20x2,0	M6x15		50	0,15

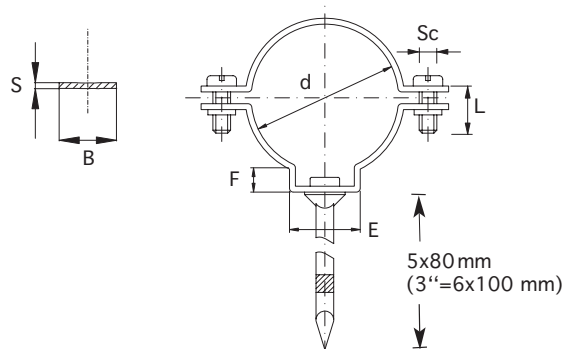
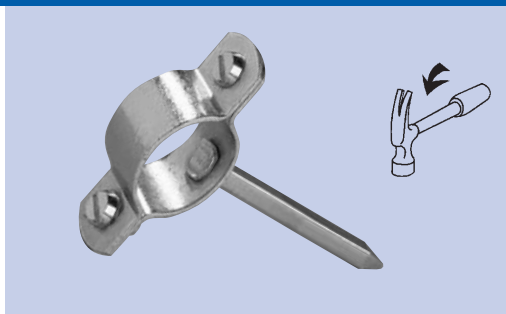

DSC W

Obejma ze szpilką

- kwadratowa szpilka do rur kanalizacyjnych:
DN70 - 80 mm,
DN100 - 100 mm,
DN125 - 140 mm.
- wkręty M6
- wykończenie: ocynk galwaniczny
- profil stalowy (B x S)
- do rur o średnicach 32 - 133 mm

N ^o	DN	d mm	B x S mm	Sc x L		kg/1
400293	DN 32	32	20x1,5	M6x15	50	0,06
400294	DN 40	42	20x1,5	M6x15	50	0,08
400295	DN 50	53	20x2,0	M6x15	50	0,10
400296	DN 70	73	20x2,0	M6x15	50	0,13
400297	DN 100	102	20x2,0	M6x15	50	0,15
400298	DN 125	133	20x2,0	M6x15	25	0,29

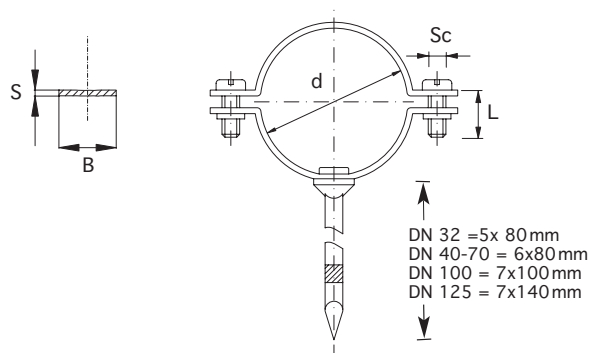
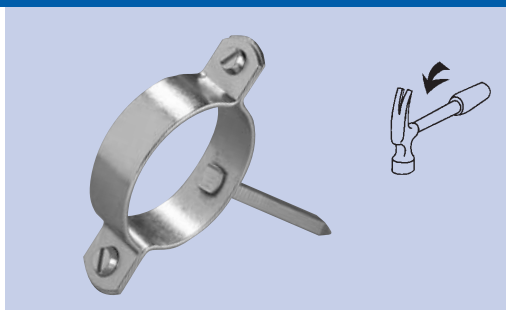

DSC P

Obejma ze szpilką

- kwadratowa szpilka do DN70 - 80 mm, DN150 - 100mm, DN200 - 120 mm
- do rur plastikowych
- wkręty M6
- wykończenie: ocynk galwaniczny
- profil stalowy (B x S)
- do rur o średnicach 40 - 200 mm

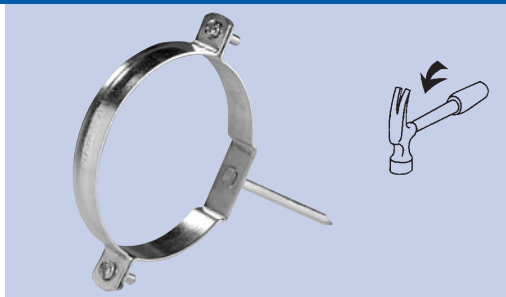

N ^o	DN	d mm	B x S mm	Sc x L	E x F		kg/1
400305	DN 40	40	20x2,0	M6x15	25x7	50	0,08
400306	DN 50	50	20x2,0	M6x15	25x7	50	0,08
400307	DN 70	75	20x2,0	M6x15	40x8	50	0,12
400308	DN 100	110	20x2,0	M6x20	45x9	50	0,17
400309	DN 125	125	20x2,0	M6x20	45x9	25	0,19
400310	DN 150	160	20x2,0	M6x20		25	0,22
400311	DN 200	200	20x2,5	M6x20		25	0,40

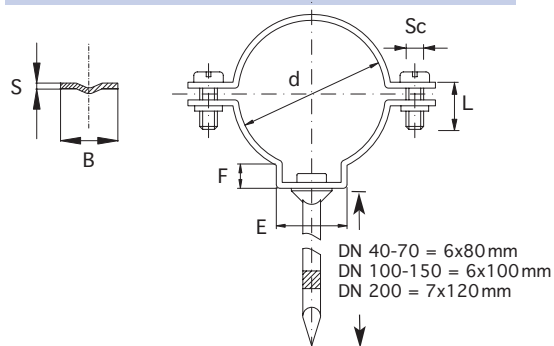

1HPS

Zacisk (mocowany gwoździem)

- otwór mocowania \varnothing 7 mm
- do szybkiego montażu przy pomocy przyrządu do wbijania gwoździ HIBT
- wykończenie: ocynk galwaniczny
- profil stalowy: 20 x 1,5 mm (B x S)
- do rur o średnicach 20 - 28 mm

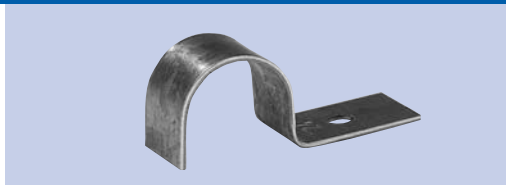

N ^o	\varnothing , ,	d mm	H mm		kg/1
400672	3/8	20	7	100	0,02
400673	1/2	25	7	100	0,02
400674	3/4	28	7	100	0,02

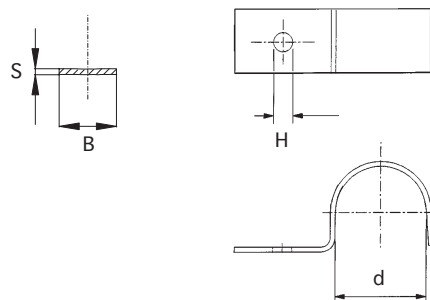

2PS

Zacisk podwójny (mocowany gwoździem)

- otwór mocowania \varnothing 7 mm
- do szybkiego montażu równoległych rur przy pomocy urządzenia do wbijania gwoździ Nail Tool HIBT
- wykończenie: ocynk galwaniczny
- profil stalowy: 20 x 1,5 mm (B x S)
- do rur o średnicach 20 - 28 mm



N ^o	\varnothing , ,	d mm	H mm		kg/1
400675	3/8	20	7	100	0,03
400676	1/2	25	7	100	0,03
400677	3/4	28	7	100	0,04

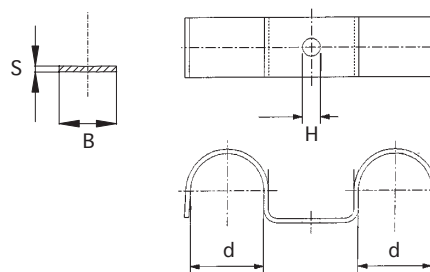

2HPS



Taśma

- otwór do mocowania \varnothing 7 mm
- do szybkiego montażu przy pomocy przyrządu do wbijania gwoździ HIBT
- wykończenie: ocynk galwaniczny
- profil stalowy: 20 x 1,0 mm (B x S)
- do rur o średnicach 17,2 - 60,3 mm

N ^o	∅	d mm	H mm		kg/1
400678	3/8	17,2	7	100	0,01
400679	1/2	21,3	7	100	0,01
400680	3/4	26,9	7	100	0,02
400681	1	33,7	7	100	0,02
400682	1 1/4	42,4	7	100	0,03
400683	1 1/2	48,3	7	100	0,03
400684	2	60,3	7	100	0,03

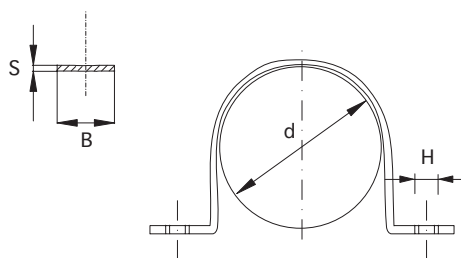

HIB

Przyrząd do wbijania gwoździ

- do zacisków i taśm
- bez gwintu, z ostrzem
- utwardzona stal

N ^o	d mm	L	L1	L2		kg/1
400426	4	24	14	8	200	0,01
400427	4	28	18	8	200	0,01

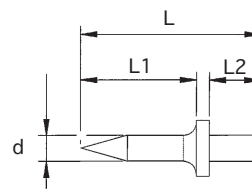
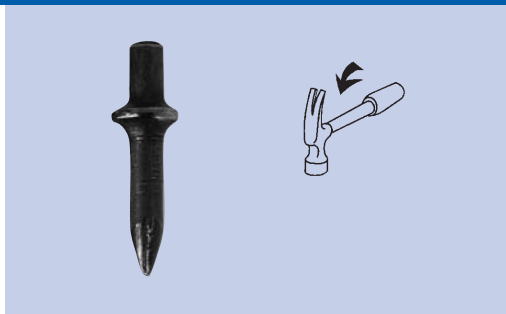

HIBT

Przyrząd do wbijania gwoździ

- do gwoździ HIB
- bezpieczne i niezawodne
- zapewnia bezpieczeństwo także w trudnodostępnych miejscach

N ^o		kg/1
400428	1	0,48

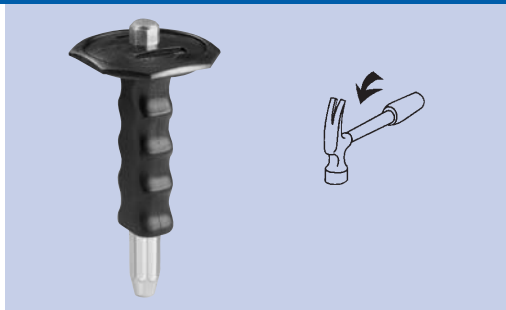



RS DIN

Obejma do dużych obciążeń

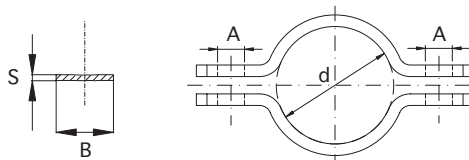
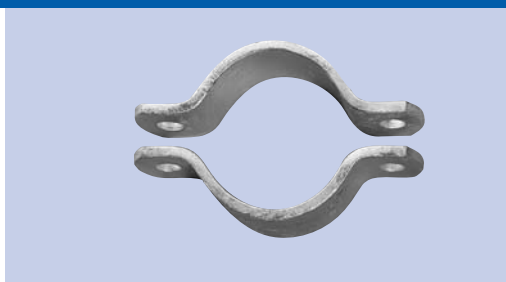
- spełnia wymagania DIN 3567A
- profil stalowy (B x S)
- zaokrąglone brzegi
- gięta na zimno
- czarna stal (stal galwanizowana i nierdzewna dostępna na zamówienie)
- 1 sztuka = 1 para



N ^o	d mm	B x S mm	A		kg/1
400148	20	30x5	11,5	1	0,16
400149	21,3	30x5	11,5	1	0,16
400150	25	30x5	11,5	1	0,17
400151	26,9	30x5	11,5	1	0,18
400152	30	30x5	11,5	1	0,19
400153	33,7	30x5	11,5	1	0,20
400154	38	30x5	11,5	1	0,21
400155	42,4	30x5	11,5	1	0,23
400156	44,5	30x5	11,5	1	0,25
400157	48,3	30x5	11,5	1	0,26
400158	54	40x6	14,0	1	0,51
400159	57	40x6	14,0	1	0,53
400160	60,3	40x6	14,0	1	0,56
400161	70	40x6	14,0	1	0,60
400162	76,1	40x6	14,0	1	0,64
400163	82	40x6	14,0	1	0,62
400164	88,9	40x6	14,0	1	0,73
400165	95	40x6	14,0	1	0,95
400166	102	40x6	18,0	1	1,48
400167	108	50x8	18,0	1	1,52
400168	114,3	50x8	18,0	1	1,59
400169	121	50x8	18,0	1	1,65
400170	133	50x8	18,0	1	1,71
400171	139,7	50x8	18,0	1	1,81

N ^o	d mm	B x S mm	A		kg/1
400172	154	50x8	18,0	1	1,90
400173	159	50x8	18,0	1	1,95
400174	168,3	50x8	18,0	1	1,99
400175	180	50x8	18,0	1	2,15
400176	194	50x8	18,0	1	2,35
400177	219,1	50x8	18,0	1	2,61
400178	225	50x8	18,0	1	2,75
400179	245	60x8	23,0	1	3,44
400180	267	60x8	23,0	1	3,72
400181	273	60x8	23,0	1	3,75
400182	280	60x8	23,0	1	4,00
400183	299	60x8	23,0	1	4,10
400184	315	60x8	23,0	1	4,30
400185	323,9	60x8	23,0	1	4,52
400186	355,6	60x8	23,0	1	4,78
400187	368,3	60x8	23,0	1	4,95
400188	406,4	70x10	27,0	1	8,07
400189	419	70x10	27,0	1	8,10
400190	457	70x10	27,0	1	9,00
400191	508	70x10	27,0	1	9,80
400192	521	70x10	27,0	1	10,20
400193	610	70x10	27,0	1	11,00
400194	711	70x10	27,0	1	13,00
400195	812	70x10	27,0	1	15,00

RSS

Zestawy śrub do obejm do dużych obciążeń

- czarna stal

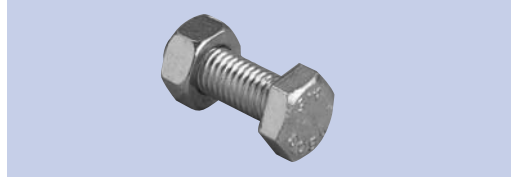

N ^o	DN	Ø mm		kg/1
400244	40	M10x30	1	0,04
400245	50-80	M12x35	1	0,06
400246	100-200	M16x45	1	0,13
400247	250-350	M20x50	1	0,24
400248	400	M24x60	1	0,42

śruba z nakrętką sześciokątną

do DN40	48,3mm	M10x30
DN50 do DN80	54-95mm	M12x35
DN100 do DN200	102-225mm	M16x45
DN250 do DN350	245-368,3mm	M20x50
od DN400	406,4mm	M24x60

UPH



Hak uniwersalny

- płaskownik, kuty
- do rur stalowych, żeliwnych i ołowianych
- do rur o średnicach 17,2 - 114,3 mm

N ^o	d "	d mm	P		kg/1
400312	3/8	17,2	0	100	0,01
400313	1/2	21,3	0	100	0,02
400314	3/4	26,9	0	100	0,03
400315	1	33,7	0	100	0,03
400316	1 1/4	42,4	0	100	0,05
400317	1 1/2	48,3	0	100	0,05
400318	2	60,3	0	100	0,07
400319	3/8	17,2	1	100	0,01
400320	1/2	21,3	1	100	0,02
400321	3/4	26,9	1	100	0,02
400322	1	33,7	1	100	0,02
400323	1 1/4	42,4	1	100	0,04
400324	1 1/2	48,3	1	100	0,05
400325	2	60,3	1	100	0,06
400326	2 1/2	76,1	1	100	0,13
400327	4	114,3	1	100	0,24

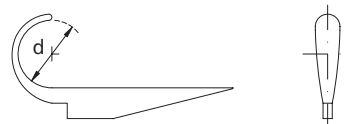
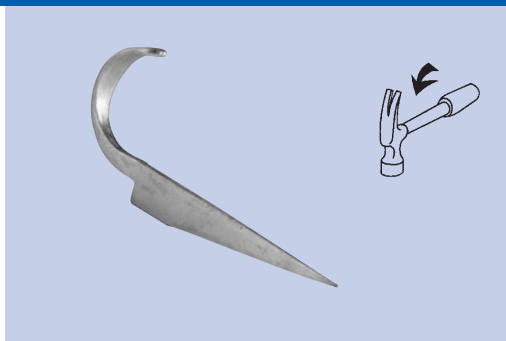

DPC 140 • DPC 200

Obejma do rur kanalizacyjnych

- spełnia wymagania DIN 18461
- do dużych obciążeń z zamykaniem zawiasowym
- pierścień ze stali nierdzewnej, z uszczelką
- wykończenie: cynkowane na gorąco
- profil stalowy: 28 x 2,0 mm, (B x S)
- do rur o średnicach 60 - 150 mm

N ^o	L mm	d mm		kg/1
400552	140	60	25	0,20
400553	140	76	25	0,25
400554	140	80	25	0,25
400555	140	87	25	0,25
400556	140	100	25	0,26
400557	140	120	25	0,28
400558	140	150	25	0,34
400796	200	60	25	0,26
400797	200	76	25	0,26
400798	200	80	25	0,28
400799	200	87	25	0,28
400800	200	100	25	0,30
400801	200	120	25	0,32
400802	200	150	25	0,30

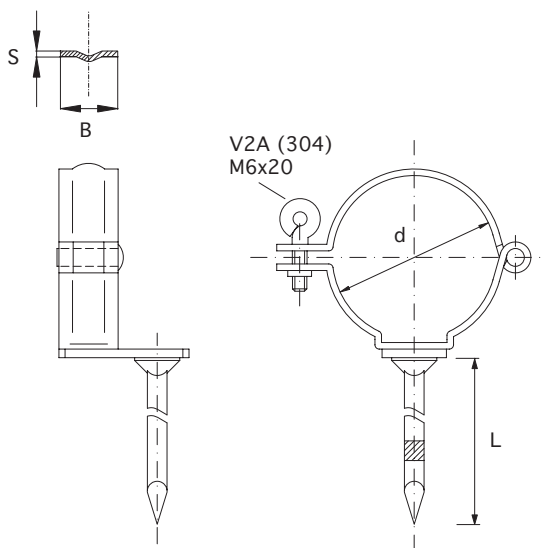
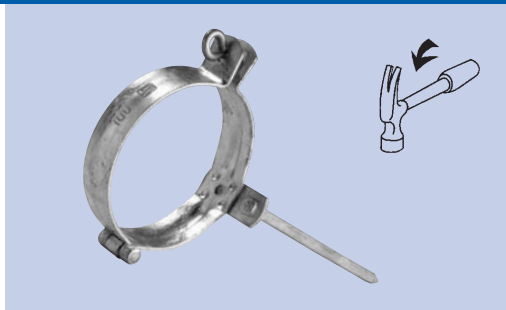

DPCM10

Obejma do rur kanalizacyjnych

- spełnia wymagania DIN 18461
- do dużych obciążeń z zamykaniem zawiasowym
- nakrętka M10
- śruba pierścieniowa ze stali nierdzewnej, z uszczelką
- wykończenie: cynkowane na gorąco
- profil stalowy: 28 x 2,0 mm, (B x S)
- do rur o średnicach 60 - 150 mm

N ^o	d mm		kg/1
400559	60	25	0,24
400560	76	25	0,24
400561	80	25	0,25
400562	87	25	0,18
400563	100	25	0,21
400564	120	25	0,28
400565	150	25	0,32

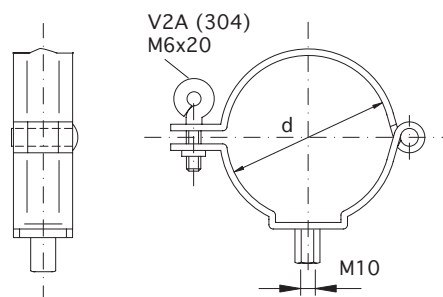
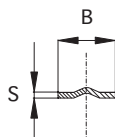

SDPC

Kwadratowa obejma do rur kanalizacyjnych

- spełnia wymagania DIN 18461
- do dużych obciążeń z zamykaniem zawiasowym
- 2 śruby pierścieniowe ze stali nierdzewnej, z uszczelkami
- wykończenie: cynkowane na gorąco
- profil stalowy: 28 x 2,0 mm, (B x S)
- do rur kwadratowych od 60 - 120 mm

N ^o	L mm	d mm		kg/1
401170	140	60	25	0,24
401171	140	80	25	0,24
401172	140	100	25	0,32
401173	140	120	25	0,31

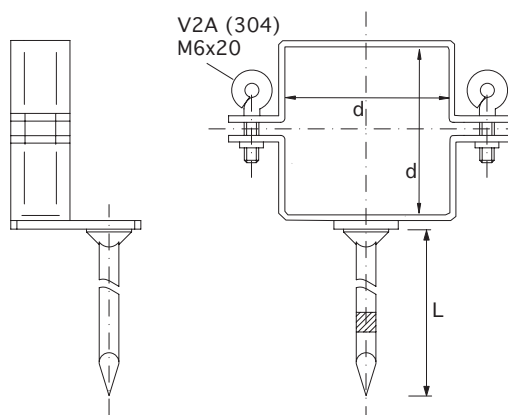
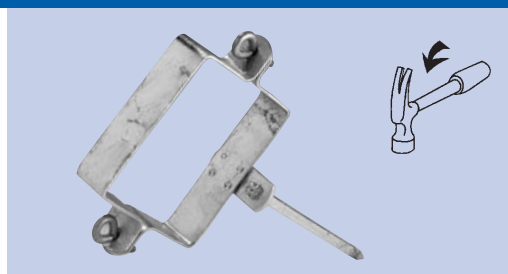
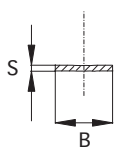

DPC WP

Rozeta szpilki

- do kwadratowych szpilek
- "czysta" instalacja
- materiał: PE
- kolor: szary

N ^o		kg/1
589299	100	0,01



U-BOLT DIN



Mocowanie U do dużych obciążeń

- spełnia wymagania DIN 3570
- w zestawie z 2 nakrętkami sześciokątnymi
- wykończenie: ocynk galwaniczny

N ^o	M	∅	DN	d mm	H		kg/1
400254	10	1/2	15	21,3	55	1	0,08
400255	10	3/4	20	26,9	70	1	0,09
400256	10	1	25	33,7	76	1	0,10
400257	10	1 1/4	32	42,4	86	1	0,11
400258	10	1 1/2	40	48,3	92	1	0,12
400259	12	2	50	60,3	109	1	0,20
400260	12	2 1/2	65	76,1	125	1	0,23
400261	12	3	80	88,9	138	1	0,28
400262	16	4	100	114,3	171	1	0,52
400263	16	5	125	139,7	191	1	0,65
400264	16	6	150	168,3	217	1	0,74
400265	20	8	200	219,1	283	1	0,75
400266	20	10	250	273	334	1	1,68
400267	20	12	300	323,9	385	1	2,04
400268	24		350	368	435	1	3,11
400269	24	16	400	419	487	1	3,52
400270	24	20	500	508	589	1	4,34

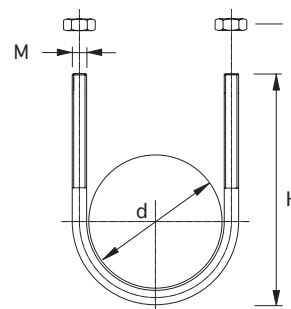

U-BOLT

Mocowanie U do małych obciążeń

- w zestawie z 4 nakrętkami sześciokątnymi
- wykończenie: ocynk galwaniczny

N ^o	M	∅	DN	d mm	H		kg/1
599100	6	1/4		13	28	100	0,01
599110	6	3/8	10	17	36	100	0,01
599120	6	1/2	15	21	40	100	0,01
599130	8	3/4	20	27	50	100	0,04
599140	8	1	25	34	55	100	0,04
599150	8	1 1/4	32	42	68	100	0,06
599160	8	1 1/2	40	49	70	100	0,06
599170	8	2	50	60	80	50	0,08
599180	8	2 1/2	65	76	110	50	0,10
599190	10	3	80	90	115	50	0,17
599200	10	4	100	114	156	25	0,22
599210	10	4 3/4		135	190	25	0,26
599220	12	5	125	140	185	25	0,40
599230	14	5 1/2		160	210	10	0,62
599240	14	6	150	168	210	10	0,65
599280	16			193	232	10	1,92
599250	16	8	200	219	270	1	1,05
599260	16	10	250	273	315	1	1,31
599270	18	12	300	323	371	1	1,85

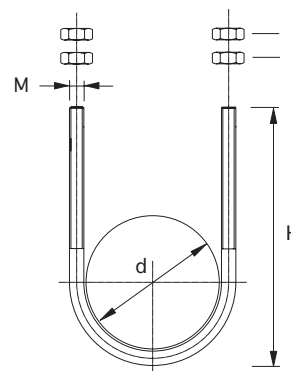

OD

Zaciski do rur

- pasuje do profili i wsporników CADDY® ERISTRUT
- wkręt sześciokątny z nacięciem
- do mocowania rur i przewodów
- średnica rury od 6 - 221 mm
- wykończenie: ocynk galwaniczny



N ^o	Ø	d mm		kg/1
598811		6-8	100	0,05
598812	1/8	8-11	100	0,05
598813		11-12	100	0,05
598814	3/8	15-17	100	0,06
598815		18-20	100	0,06
598816	1/2	21-23	100	0,06
598817		23-26	100	0,06
598818	3/4	26-29	100	0,06
598819		29-32	100	0,06
598822	1	32-36	50	0,07
598823		36-39	50	0,07
598824		39-42	50	0,07
598825	1 1/4	42-45	50	0,07
598826	1 1/2	46-50	50	0,08
598827		50-54	50	0,08
598828		52-56	50	0,11
598829		56-60	50	0,12
598831	2	60-63	50	0,13
598832		62-64	50	0,13
598833		64-67	50	0,13
598834		67-71	50	0,14
598835		71-74	25	0,16
598836	2 1/2	74-77	25	0,17
598837		77-80	25	0,20
598838		83-86	25	0,21
598839	3	86-90	25	0,23
598842		96-100	25	0,24
598843		100-103	25	0,24
598844		109-112	25	0,26
598845	4	112-115	25	0,28
598846		115-118	25	0,32
598847		125-128	25	0,38
598848		132-135	25	0,40
598849		135-138	25	0,42
598853	5	138-141	25	0,45
598854		148-151	25	0,45
598855		157-160	25	0,46
598856		160-164	25	0,62
598857		164-167	25	0,65
598858	6	167-170	25	0,69
598859		176-179	25	0,72
598862		179-182	25	0,76
598863		189-192	25	0,89
598864		196-200	25	0,92
598865	8	218-221	1	0,99

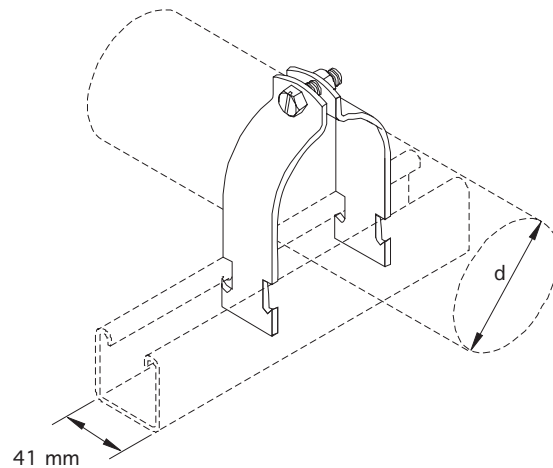

EPB



Obejma do instalacji tryskaczowej, bez nakrętki

- spełnia wymagania FM
- wykończenie: ocynk galwaniczny
- do rur o średnicach 1/2" - 8"

N ^o	Ø , ,	DN	G Ø mm	H1 mm	H2 mm	P		kg/1
179500	1/2	15	11	35	20	1	50	0,05
179501	3/4	20	11	35	20	1	50	0,05
179502	1	25	11	43	26	1	50	0,05
179503	1 1/4	32	11	50	30	1	50	0,05
179504	1 1/2	40	11	60	35	1	50	0,06
179505	2	50	11	60	30	1	50	0,07
179506	2 1/2	65	13	81	33	1	25	0,1
179507	3	80	13	85	40	1	25	0,13
179508	4	100	13	113	56	1	25	0,2
179509	5	125	13	123	58	1	25	0,45
179511	6	150	13	145	60	1	25	0,48
179512	8	200	18	200	90	1	10	0,75

